

**3 Phase bridge  
Trench + Field Stop IGBT®  
Power Module**

**$V_{CES} = 1200V$   
 $I_C = 35A @ T_c = 80^\circ C$**

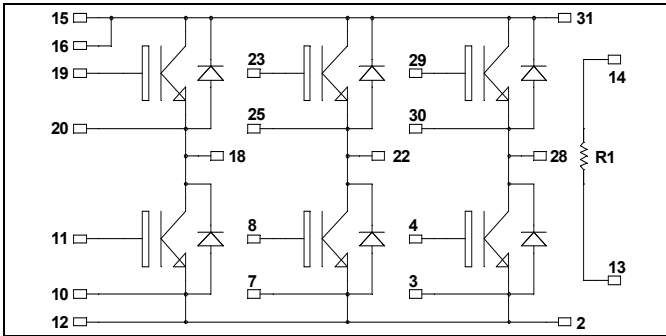

It is recommended to connect a decoupling capacitor between pins 31 & 2 to reduce switching overvoltages, if DC Power is connected between pins 15, 16 & 12. Pins 15 & 16 must be shorted together.

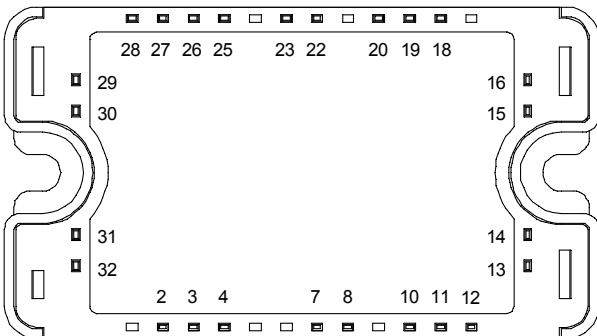

### Application

- Motor control

### Features

- Trench + Field Stop IGBT® Technology
  - Low voltage drop
  - Low tail current
  - Switching frequency up to 20 kHz
  - Soft recovery parallel diodes
  - Low diode VF
  - Low leakage current
  - RBSOA and SCSOA rated
- Kelvin emitter for easy drive
- Very low stray inductance
- High level of integration
- Internal thermistor for temperature monitoring

### Benefits

- Outstanding performance at high frequency operation
- Direct mounting to heatsink (isolated package)
- Low junction to case thermal resistance
- Solderable terminals both for power and signal for easy PCB mounting
- Low profile
- RoHS compliant

### Absolute maximum ratings

Symbol	Parameter	Max ratings	Unit
$V_{CES}$	Collector - Emitter Breakdown Voltage	1200	V
$I_C$	Continuous Collector Current	$T_c = 25^\circ C$	55
		$T_c = 80^\circ C$	35
$I_{CM}$	Pulsed Collector Current	$T_c = 25^\circ C$	70
$V_{GE}$	Gate - Emitter Voltage	$\pm 20$	V
$P_D$	Maximum Power Dissipation	$T_c = 25^\circ C$	208
RBSOA	Reverse Bias Safe Operating Area	$T_j = 125^\circ C$	70A@1150V

**CAUTION:** These Devices are sensitive to Electrostatic Discharge. Proper Handling Procedures Should Be Followed. See application note APT0502 on [www.microsemi.com](http://www.microsemi.com)

All ratings @  $T_j = 25^\circ\text{C}$  unless otherwise specified

**Electrical Characteristics**

Symbol	Characteristic	Test Conditions	Min	Typ	Max	Unit
$I_{CES}$	Zero Gate Voltage Collector Current	$V_{GE} = 0\text{V}$ $V_{CE} = 1200\text{V}$	$T_j = 25^\circ\text{C}$		250	$\mu\text{A}$
			$T_j = 125^\circ\text{C}$		500	
$V_{CE(sat)}$	Collector Emitter saturation Voltage	$V_{GE} = 15\text{V}$ $I_C = 35\text{A}$	$T_j = 25^\circ\text{C}$	1.7	2.1	V
			$T_j = 125^\circ\text{C}$	2.0		
$V_{GE(th)}$	Gate Threshold Voltage	$V_{GE} = V_{CE}, I_C = 1.5\text{mA}$	5.0	5.8	6.5	V
$I_{GES}$	Gate – Emitter Leakage Current	$V_{GE} = 20\text{V}, V_{CE} = 0\text{V}$			400	nA

**Dynamic Characteristics**

Symbol	Characteristic	Test Conditions	Min	Typ	Max	Unit
$C_{ies}$	Input Capacitance	$V_{GE} = 0\text{V}, V_{CE} = 25\text{V}$ $f = 1\text{MHz}$		2.5		nF
$C_{res}$	Reverse Transfer Capacitance			0.15		
$T_{d(on)}$	Turn-on Delay Time	Inductive Switching ( $25^\circ\text{C}$ ) $V_{GE} = \pm 15\text{V}$ $V_{Bus} = 600\text{V}$ $I_C = 35\text{A}$ $R_G = 27\Omega$		90		ns
$T_r$	Rise Time			30		
$T_{d(off)}$	Turn-off Delay Time			420		
$T_f$	Fall Time			70		
$T_{d(on)}$	Turn-on Delay Time	Inductive Switching ( $125^\circ\text{C}$ ) $V_{GE} = \pm 15\text{V}$ $V_{Bus} = 600\text{V}$ $I_C = 35\text{A}$ $R_G = 27\Omega$		90		ns
$T_r$	Rise Time			50		
$T_{d(off)}$	Turn-off Delay Time			520		
$T_f$	Fall Time			90		
$E_{on}$	Turn-on Switching Energy	$V_{GE} = \pm 15\text{V}$ $V_{Bus} = 600\text{V}$ $I_C = 35\text{A}$ $R_G = 27\Omega$	$T_j = 125^\circ\text{C}$		3.5	mJ
$E_{off}$	Turn-off Switching Energy				4.1	

**Reverse diode ratings and characteristics**

Symbol	Characteristic	Test Conditions	Min	Typ	Max	Unit
$V_{RRM}$	Maximum Peak Repetitive Reverse Voltage		1200			V
$I_{RM}$	Maximum Reverse Leakage Current	$V_R = 1200\text{V}$	$T_j = 25^\circ\text{C}$		100	$\mu\text{A}$
			$T_j = 150^\circ\text{C}$		500	
$I_F$	DC Forward Current			30		A
$V_F$	Diode Forward Voltage	$I_F = 30\text{A}$		2.6	3.1	V
		$I_F = 60\text{A}$		3.2		
		$I_F = 30\text{A}$	$T_j = 125^\circ\text{C}$	1.8		
$t_{rr}$	Reverse Recovery Time	$I_F = 30\text{A}$ $V_R = 800\text{V}$ $di/dt = 200\text{A}/\mu\text{s}$	$T_j = 25^\circ\text{C}$	300		ns
			$T_j = 125^\circ\text{C}$	380		
$Q_{rr}$	Reverse Recovery Charge	$I_F = 30\text{A}$ $V_R = 800\text{V}$ $di/dt = 200\text{A}/\mu\text{s}$	$T_j = 25^\circ\text{C}$	360		nC
			$T_j = 125^\circ\text{C}$	1700		

**Temperature sensor NTC** (see application note APT0406 on [www.microsemi.com](http://www.microsemi.com) for more information).

Symbol	Characteristic	Min	Typ	Max	Unit
R <sub>25</sub>	Resistance @ 25°C		50		kΩ
B <sub>25/85</sub>	T <sub>25</sub> = 298.15 K		3952		K

$$R_T = \frac{R_{25}}{\exp\left[B_{25/85}\left(\frac{1}{T_{25}} - \frac{1}{T}\right)\right]}$$

T: Thermistor temperature  
 R<sub>T</sub>: Thermistor value at T

### Thermal and package characteristics

Symbol	Characteristic	Min	Typ	Max	Unit		
R <sub>thJC</sub>	Junction to Case Thermal Resistance	IGBT		0.6	°C/W		
		Diode		1.2			
V <sub>ISOL</sub>	RMS Isolation Voltage, any terminal to case t=1 min, I isol<1mA, 50/60Hz	2500			V		
T <sub>J</sub>	Operating junction temperature range	-40		150	°C		
T <sub>STG</sub>	Storage Temperature Range	-40		125			
T <sub>C</sub>	Operating Case Temperature	-40		100			
Torque	Mounting torque		To heatsink	M4	2.5	4.7	N.m
Wt	Package Weight					110	g

### SP3 Package outline (dimensions in mm)

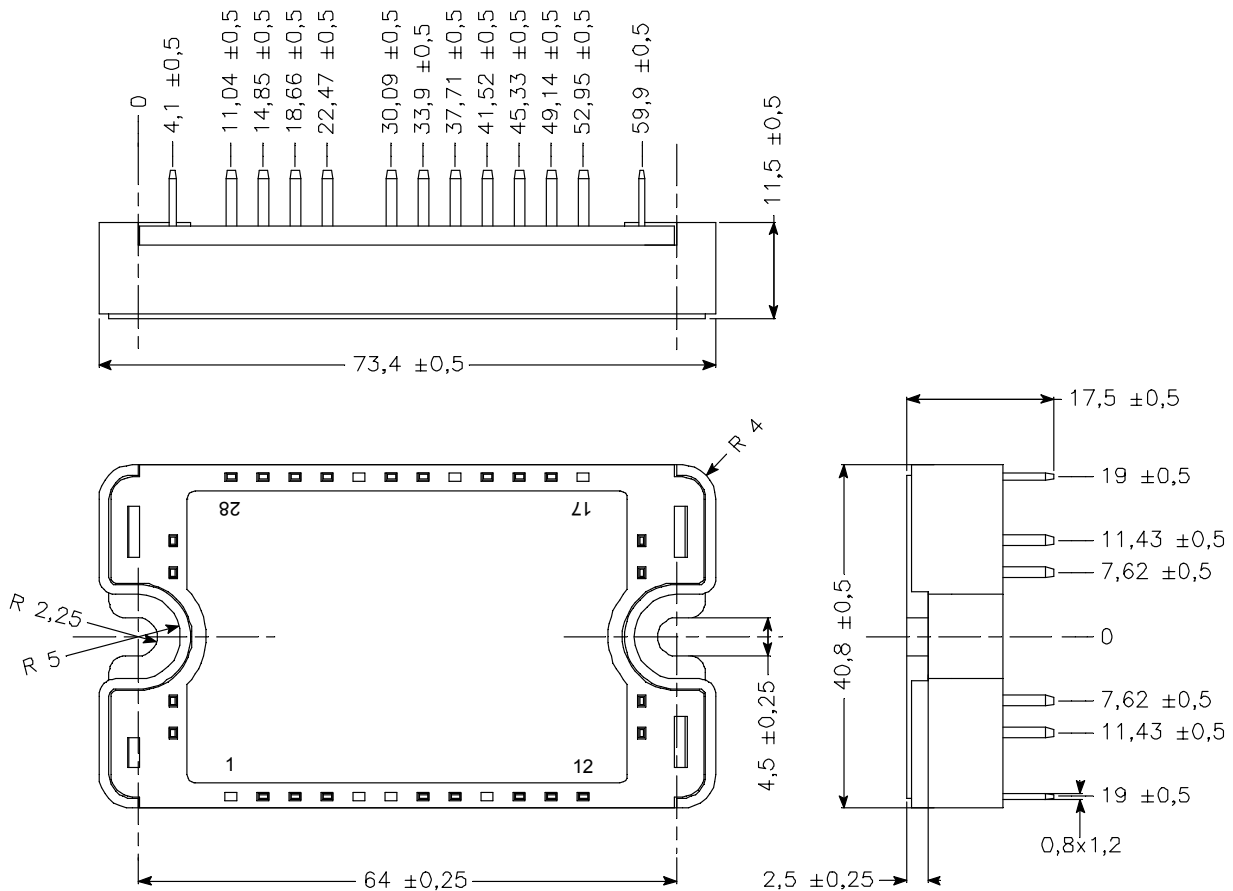

See application note 1901 - Mounting Instructions for SP3 Power Modules on [www.microsemi.com](http://www.microsemi.com)

## Typical Performance Curve

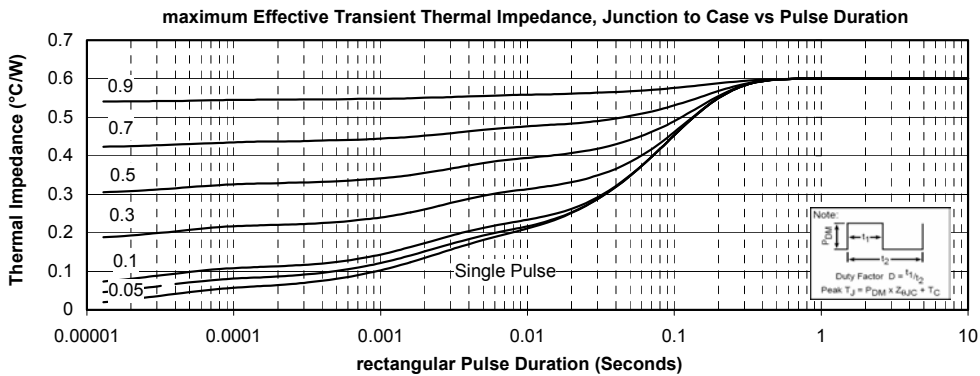
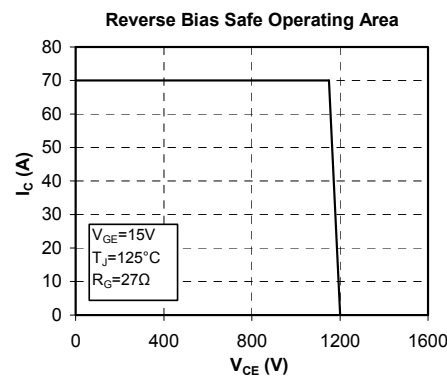
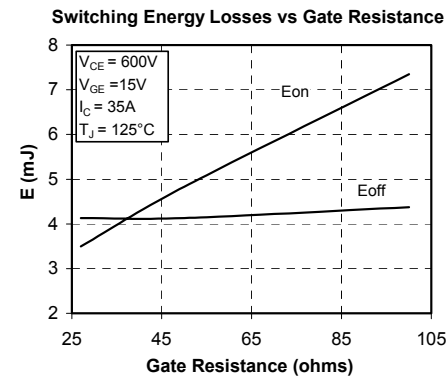
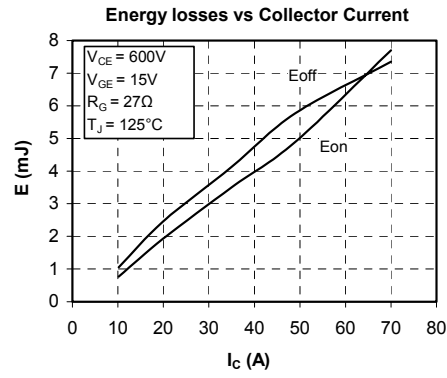
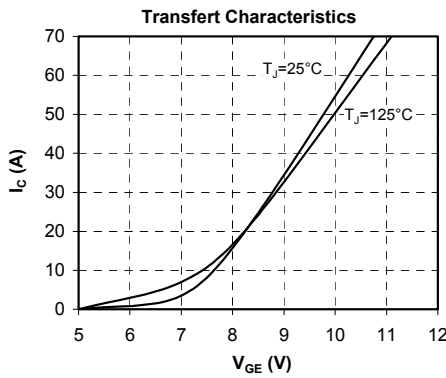
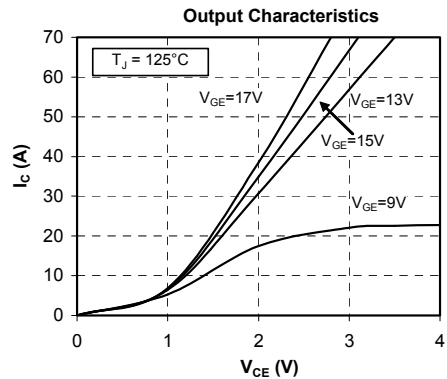
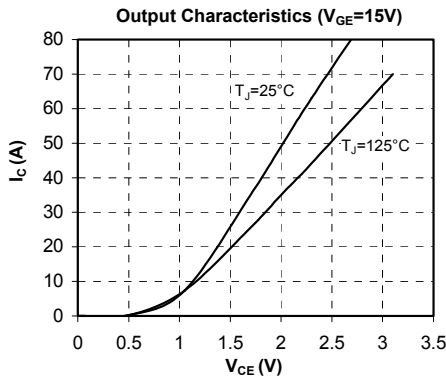

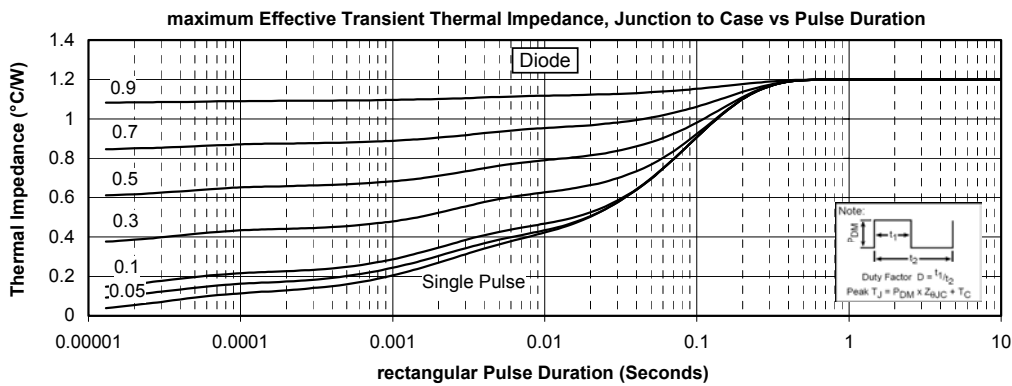
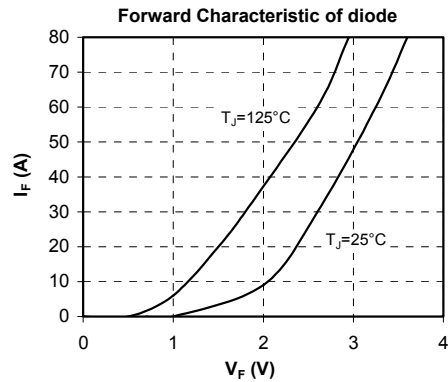
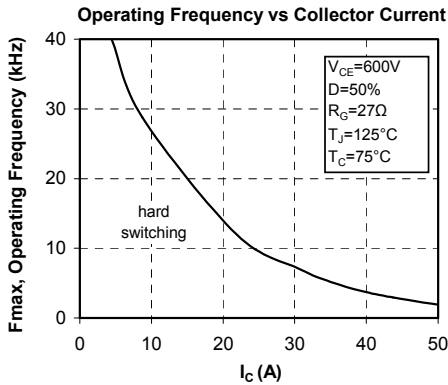

Microsemi reserves the right to change, without notice, the specifications and information contained herein

Microsemi's products are covered by one or more of U.S. patents 4,895,810 5,045,903 5,089,434 5,182,234 5,019,522 5,262,336 6,503,786 5,256,583 4,748,103 5,283,202 5,231,474 5,434,095 5,528,058 and foreign patents. U.S. and Foreign patents pending. All Rights Reserved.